

DECOR HELIOS WALL

LEDVANCE

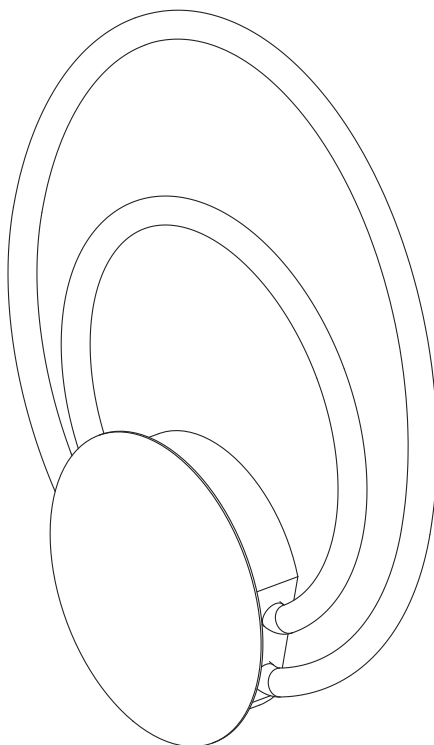





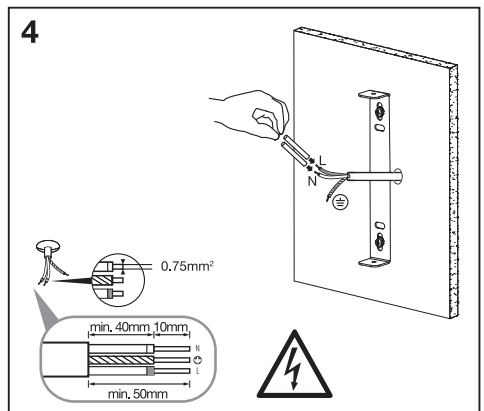
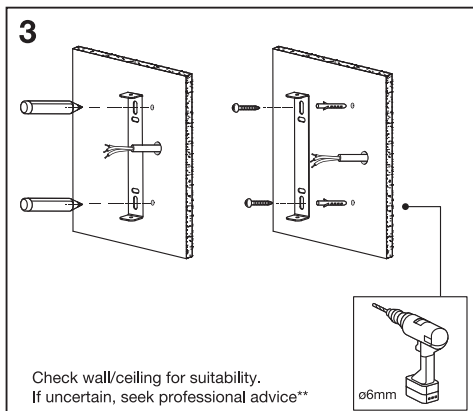
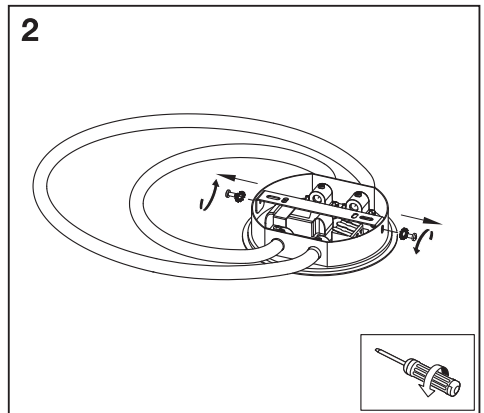
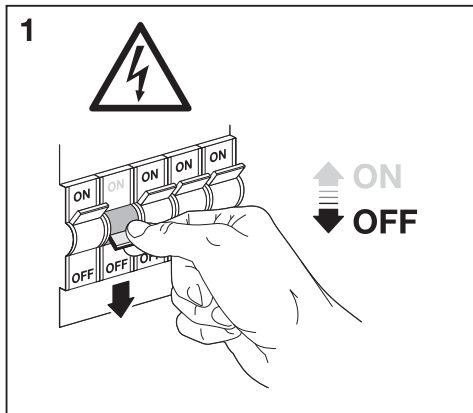
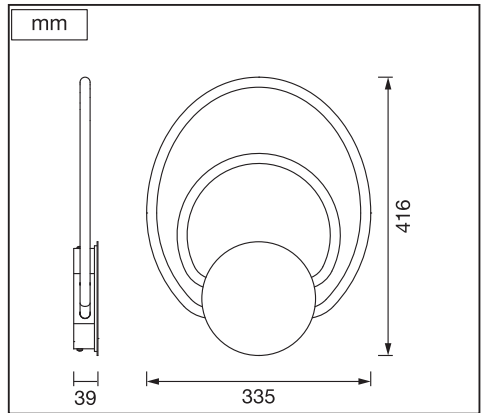
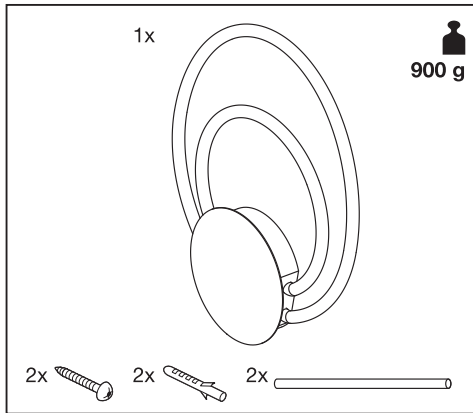

	EAN	W	lm Light Source	lm Output	K	IP	⊖ (°C)	V~	mA	Hz	DF	▽ (°)	👉
DECOR HELIOS WALL 12W 830 CLICK SEL	4058075842144	12	1470	960	3000	20	-20... +40	220-240	65	50/60	≥0.7	360°	20000

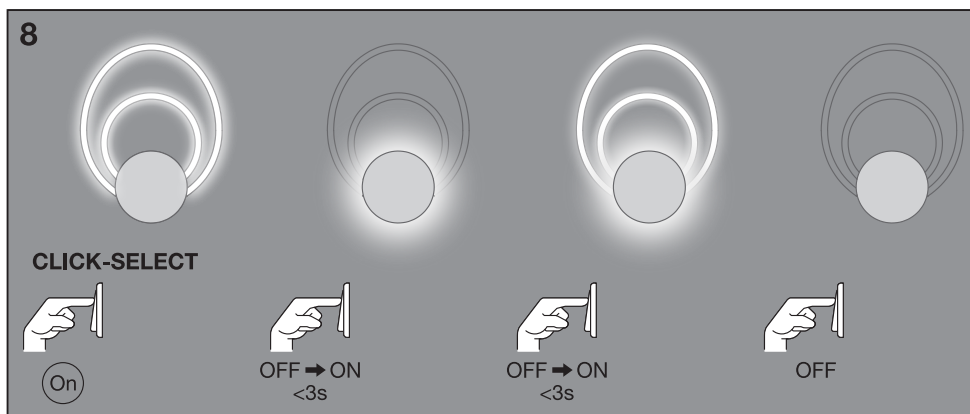
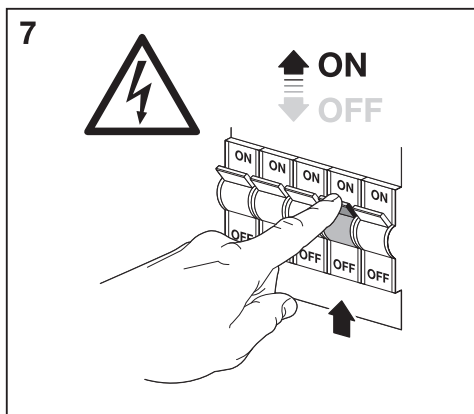
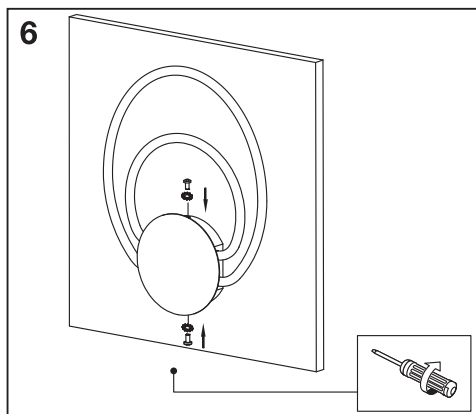
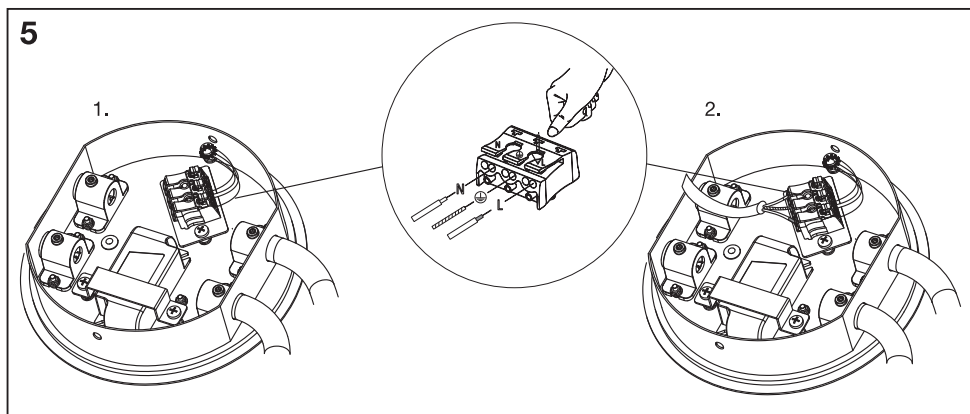



























DECOR HELIOS WALL





























DECOR HELIOS WALL



						 * X =
		EAN	n			
DECOR HELIOS WALL 10W 830 CLICK SEL	4058075842144	1	AC63503		D	
		1	AC63508		D	
		1	AC63507		E	

*  Dieses Produkt enthält eine Lichtquelle der Energieeffizienzklasse <X>.  This product contains a light source of energy efficiency class <X>.  Ce produit contient une source lumineuse de classe d'efficacité énergétique <X>.  Questo prodotto contiene una sorgente luminosa di classe di efficienza energetica <X>.  Este producto contiene una fuente luminosa de la clase de eficiencia energética <X>.  Este produto contém uma fonte de luz da classe de eficiência energética <X>.  Το προϊόν αυτό περιέχει φωτεινή πηγή της τάξης ενεργειακής απόδοσης <X>.  Dit product bevat een lichtbron van energie-efficiëntieklasse <X>.  Denna produkt innehåller en ljuskälla med energieeffektivitetsklass <X>.  Tämä tuote sisältää valonlähteen, jonka energiatehokkuusluokka on <X>.  Dette produktet inneholder en lyskilde med energieffektivitetsklasse <X>.  Dette produkt inneholder en lyskilde i energieffektivitetsklasse <X>.  Tento výrobek obsahuje světelný zdroj s třídou energetické účinnosti <X>.  Данный продукт содержит энергосберегающий источник света (класс <X>).  Ez a termék egy <X> energiatékonysági osztályú fényforrást tartalmaz.  Ten produkt zawiera źródło światła o klasie efektywności energetycznej <X>.  Tento výrobek obsahuje světelný zdroj třídy energetické účinnosti <X>.  Ta izdelek vsebuje svetlobni vir razreda enerjske učinkovitost <X>.  Bu ürün, enerji verimliliği sınıfında bir ışık kaynağı içerir <X>.  Ovaj proizvod sadržava izvor svetlosti klase energetske učinkovitosti <X>.  Acest produs conține o sursă de lumină cu classa de eficiență energetică <X>.  Tozi produkt vjučova svetlinen izščnik s klas na enerģijna eřektivnost <X>.  Toode sisaldab energiatõhususe klassi <X> valgusallikat.  Šiame gaminyje yra šviesos šaltinis, kurio energijos vartojimo efektyvumo klasė <X>.  Šis s ražojums satur gaismas avotu, kura energoefektivitātes klase ir <X>.  Ovaj proizvod sadrži izvor svetlosti klase energetske efikasnosti <X>.  Цей вирiв мiстить джерело свiтла класу енергоефективностi <X>.  Бул өнімдi энергия тиімдiлiгi класының жарық көзi бәр.

**  Eignung der Wand/Decke prüfen. Wenn Sie sich nicht sicher sind, lassen Sie sich beraten.  Vérifiez l'adéquation du mur/plafond. En cas d'incertitude, demandez conseil à un professionnel.  Controllare l'idoneità della parete o del soffitto. In caso di dubbi, consultare un professionista.  Compruebe la idoneidad de la pared o techo. Si no está seguro, busque asesoramiento profesional.  Verifique a adequação da parede/teto. Se não tiver a certeza, procure aconselhamento profissional.  Ελέγξτε τον τοίχο/την οροφή ως προς την καταλληλότητα. Σε περίπτωση αμφιβολίας, ζητήστε επαγγελματική συμβουλή.  Controllere wand/plafond op geschiktheid. Als u niet zeker bent, vraag dan professioneel advies.  Kontrollera vägg/tak för lämplighet. Om du är osäker, sök professionell rådgivning.  Tarkista seinän/katon sopivuus. Jos olet epävarma, kysy neuvoa ammattilaiselta.  Sjekk om veggens/taket egner seg. Oppsøk profesjonell rådgivning dersom du er usikker.  Kontrollere væg/loft for egnethed. Hvis du er usikker, skal du søge professionel rådgivning.  Zkontrolujte vhodnost stěny/stropu. Pokud si nejste jisti, vyhleďte odbornou radu.  Проверьте стену/потолок на пригодность. Если у вас есть сомнения, обратитесь за профессиональной консультацией.  Ellenõrize a fal/mennyezet alkalmasságát. Ha bizonytalan, kérjen szaksterű tanácsot.  Sprawdź, czy ściana/sufit nadają się do montażu. W razie wątpliwości zasięgnij porady wykwalifikowanej osoby.  Skontrolujte vhodnost steny/stropa. Ak si nie ste istí, vyhľadajte odbornú pomoc.  Preverite primernost stene/stropa. Če niste prepričani, poiščite nasvet strokovnjaka.  Duvaan/tavanyn ugun olup olmadığını kontrol edin. Emin değilseniz uzman bir kişiden destek alın.  Proverite prikladnost zida/stropa. Ako niste sigurni, potražite stručni savjet.  Verificati dacă peretele/tavanul este adecvat. În caz de incertitudine, solicitați consultanță de specialitate.  Proverete progodnostta na stenata/tavana. Ako ne ste sigurni, potърсете професионален съвет.  Kontrolli seinale/lakke sobivust. Kahtluse korral küsi professionaalilt nõu.  Patikrinkite sienos/lubų tinkamumą. Jei kyla abejonų, kreipkitės į specialistą.  Pārbaudiet sienu/griestu piemērotību. Neskaitrību gadījumā meklējiet profesionālu padomu.  Proverite pogodnost zida/plafona. Ako niste sigurni, potražite stručni savet.  Перевірте відповідність стiни/стелi. Якщо ви не впевненi, звернiться за професiйною консультацiєю.  Қабырғаның/тебеңнi жарамдылығын тексерiңiз. Егер сенiмдi болмасаңыз, кесiби кеңеске жүгiнiңiз.

 22
PAP
Raccolta Carta



Points de collecte sur www.quefairedemesdechets.fr

C10449057
G11199028
03.07.2024



LEDVANCE GmbH
Steinerne Furt 62
86167 Augsburg, Germany
www.ledvance.com