

# PRODUCT DATASHEET

## PL CMFT 600 P 33W 840 ZBVR

PANEL COMFORT 600 ZIGBEE GEN 1 | Square recessed panel luminaire, for 600 x 600 mm ceiling systems and Zigbee 3.0 technology

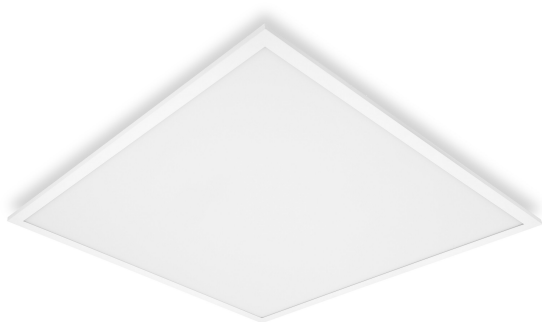

### Areas of application

- Direct replacement for recessed luminaires with fluorescent lamps
- Offices, conference rooms
- Reception areas, foyers, corridors, elevators
- Suitable for recessed ceiling systems with grid size of 600 x 600 mm

### Product benefits

- Suitable luminaire for VIVARES and other Zigbee 3.0 Light Management Systems
- Tool-free electrical connection due to push button connector
- Through-wiring possible with included connector box
- Energy savings thanks to high system efficacy: up to 130 lm/W
- High color consistency with SDCM 3
- External driver for extended flexibility and easy installation
- Low flicker light thanks to special electronic control gear
- Emergency lighting possible with LEDVANCE Emergency Conversion Box
- 5 years guarantee

### Product features

- IoT-ready luminaire with Zigbee 3.0 technology
- Extruded aluminum frame
- Polystyrene diffuser



- 5-pole terminal block, cable cross section up to 5 x 2.5 mm<sup>2</sup>
- Lifetime (L80/B10): 70,000 h (at 25 °C)

## TECHNICAL DATA

### Electrical data

Nominal wattage	33.00 W <sup>1)</sup>
Nominal voltage	220...240 V
Mains frequency	50...60 Hz
Nominal current	162.000 mA
Inrush current	4.3 A
Inrush current time T <sub>h50</sub>	440 µs
Max. number of luminaires per miniature circuit breaker B16	40
Max. number of luminaires per miniature circuit breaker C10	41
Max. number of luminaires per miniature circuit breaker C16	66
Power factor λ	> 0.90
Total harmonic distortion	< 20 %
Protection class	II
Operating mode	External LED driver
Dimming interface	Zigbee 3.0 / IoT

<sup>1)</sup> CRI80 versions of the Panel Comfort family are fulfilling the technical minimum requirements according to the German BEG subsidy program for energy efficient luminaires

### Photometrical data

Luminous flux	4320 lm <sup>1)</sup>
Luminous efficacy	130 lm/W <sup>1)</sup>
Color temperature	4000 K
Light color (designation)	Cool White
Color rendering index Ra	> 80
Standard deviation of color matching	≤3 sdc <sub>m</sub>
Low flicker	Yes
Flickering metric (Pst LM)	<1
Stroboscope effect metric (SVM)	< 0.4
Photobiological safety group acc. to EN62778	RG0
Beam angle	110 °

<sup>1)</sup> CRI80 versions of the Panel Comfort family are fulfilling the technical minimum requirements according to the German BEG subsidy program for energy efficient luminaires

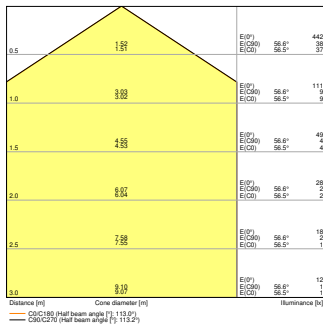

PL CMFT 600 P 33W 840 ZBVR EM CONVERSION BOX

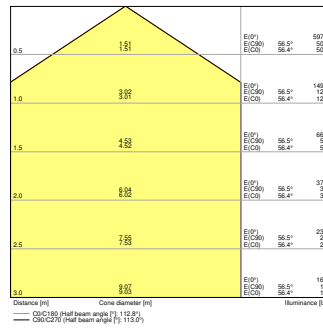

PL CMFT 600 P 33W 840 ZBVR

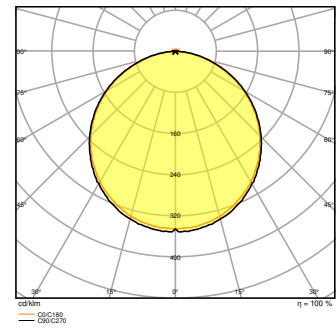

PL CMFT 600 P 33W 840 ZBVR EM CONVERSION BOX

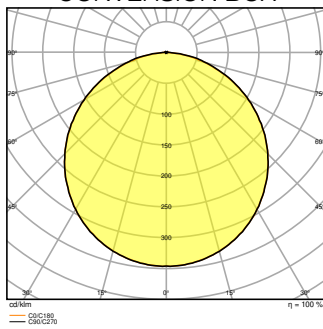

PL CMFT 600 P 33W 840 ZBVR

Dimensions & Weight

Length	595.00 mm
Width	595.00 mm
Height	32.00 mm
Product weight	1780.00 g

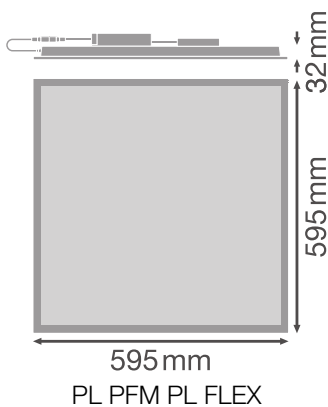

## Materials & Colors

Product color	White
Housing color	White
Body material	Steel
Cover material	Polystyrene (PS)
Light emitting surface material	Polystyrene
Glow Wire Test according to IEC 60695-2-12	650 °C
Mercury content	0.0 mg

## Application & Mounting

Ambient temperature range	-10...+50 °C
Temperature range at storage	-20...+80 °C
Type of connection	Screwless terminal, 5-Pole (L, N, PE, DA+, DA-)
Type of protection	IP40/IP20
Protection class IK (shock resistance)	IK02
Dimmable	Yes
Type of dimming	ZIGBEE
IoT ready	Support of DALI data type PART 251, 252, 253 <sup>1)</sup>
Mounting type	Recessed/Suspended/Surface
Mounting location	Ceiling
Application environment	Indoor
Mounting length	575 mm
Mounting width	575 mm
Mounting depth	50,0 mm
Adjustable	No
With light source	Yes
Replaceable light source	No

<sup>1)</sup> Internet of Things. Supports data transfer via gateway to cloud-based monitoring platforms, such as LEDVANCE VIVARES Cloud

## Lifespan

Lifespan L70/B50 at 25 °C	100000 h <sup>1)</sup>
Lifespan L80/B10 at 25 °C	70000 h <sup>1)</sup>
Lifespan L80/B50 at 25 °C	70000 h
Lifespan L90/B10 at 25 °C	48000 h
Number of switching cycles	50000

1) t[h]: L70 / B50 @ 25 °C (Ta), t[h]: L80 / B10 @ 25 °C (Ta), t[h]: L90 / B10 @ 25 °C (Ta)

**Control gear**

Output current	730 mA
ECG - Output ripple current	< 5 %
ECG - Length	148.5 mm
ECG - Width	75.5 mm
ECG - Height	32 mm
Recommended control gear	OSRAM OTI DALI 50/220-240/1A4 NFC; Tridonic LCA 45W 500-1400mA one4all SC PRE





**Certificates & Standards**

Standards	CE / CB / ENEC / UKCA / EAC
Luminaire with limited surface temperature, "D sign"	No
Ball shot safe	No
Replaceable light source (EPREL)	Not replaceable

**Additional product data**

Added function	VIVARES
----------------	---------

**Accessories Optional**









Product image	Product name	EAN
	EM CONVERSION BOX	4058075237025
	PANEL 600 SURFACE MOUNT KIT H75	4058075472914
	PANEL 600 SURFACE MOUNT KIT H70 VAL	4058075402843
	PANEL RECESSED MOUNT CLIPS VAL 4x	4058075409859



Product image	Product name	EAN
	PANEL Suspension Kit	4058075402928









**EQUIPMENT / ACCESSORIES**



- Accessories for several mounting options available
- Connector box with 5-pole terminal included
- Security rope for luminaire included
- Security brackets preinstalled
- External control gear included
- Suitable for use with separate Emergency Conversion Box

**DOWNLOAD DATA**

Documents and certificates	Document name
 User instruction / safety instructions	PL CMFT P ZBVR
 Legal information	PL CMFT P ZBVR
 Legal information	LISO Insert Panel CMFT 600 P and 625 P Zigbee
 Legal information	Informationstext 18 Abs 4 ElektroG
 Legal information	EM Insert PL COMFORT
 Declarations of conformity	CE Declaration PL CMFT ZBVR
 Declarations of conformity UKCA	UKCA Declaration PL CMFT ZBVR
 Certificates	PL CMFT ZB

Photometric and lighting design files	Document name
 IES file (IES)	PL CMFT 600 P 33W 840 ZBVR
 LDT file (Eulumdat)	PL CMFT 600 P 33W 840 ZBVR

Photometric and lighting design files		Document name
	ULD file (DIALux)	PL CMFT 600 P
	ROLF file (RELUX)	PL CMFT 600 P
	UGR file (UGR table)	PL CMFT 600 P 33W 840 ZBVR EM CONVERSION BOX
	UGR file (UGR table)	PL CMFT 600 P 33W 840 ZBVR
	Light distribution curve type cone	PL CMFT 600 P 33W 840 ZBVR EM CONVERSION BOX
	Light distribution curve type cone	PL CMFT 600 P 33W 840 ZBVR
	Light distribution curve type polar	PL CMFT 600 P 33W 840 ZBVR EM CONVERSION BOX
	Light distribution curve type polar	PL CMFT 600 P 33W 840 ZBVR

CAD/BIM files		Document name
	BIM Revit 3D	PL_CMFT
	CAD STEP 3D	PL_CMFT_600

Tender texts		Document name
	Tender documents	PANEL COMFORT 600 ZIGBEE 33W 840 ZBVR-EN

**LOGISTICAL DATA**

Product code	Packaging unit (Pieces/Unit)	Dimensions (length x width x height)	Gross weight	Volume
4099854015076	Folding box 1	52 mm x 622 mm x 649 mm	2232.00 g	20.99 dm <sup>3</sup>
4099854015083	Shipping box 4	647 mm x 222 mm x 724 mm	10808.00 g	103.99 dm <sup>3</sup>

The mentioned product code describes the smallest quantity unit which can be ordered. One shipping unit can contain one or more single products. When placing an order, for the quantity please enter single or multiples of a shipping unit.

**ADDITIONAL CATALOG INFORMATION**



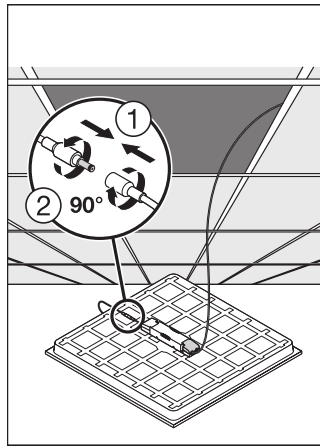
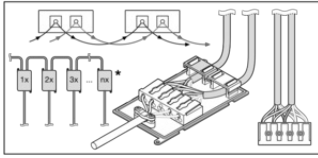

---

### References / Links

– For Guarantee see [www.ledvance.com/guarantee](http://www.ledvance.com/guarantee)

---

### DISCLAIMER

Subject to change without notice. Errors and omission excepted. Always make sure to use the most recent release.