

PRODUCT FAMILY DATASHEET

LED Retrofit RGBW lamps with remote control

Consumer LED RGBW lamps with remote control



AREAS OF APPLICATION

- Domestic applications

PRODUCT BENEFITS

- Easy installation
- Up to 80 % less energy consumption compared with ordinary light bulbs
- Individual control
- No app or smartphone required to control the lamp
- Comfortable and intuitive infrared remote control
- Switching, dimming in 4 steps and color control with the push of a button
- Color loops for dynamic color changes

PRODUCT FEATURES

- Lifetime: up to 25,000 h
- Allows for control of colors, saturation and dimming levels
- Wide range of controllable light colors including white
- Four dynamic effects: Flash, Strobe, Smooth, Mode



TECHNICAL DATA

Product description	Electrical data				Photometrical data				
	Nominal wattage	Nominal voltage	Max. lamp no. on circuit break. 10 A (B)	Max. lamp no. on circuit break. 16 A (B)	Lumen main.fact.at end of nom.life time	Light color (designation)	Color temperature	Luminous flux	Color rendering index Ra
ST CLAS A 60 FR 9 W/2700K E27 ¹⁾	9.00 W	220...240 V	130	110	0.70	Warm White	2700 K	806 lm	≥80
ST CLAS P 25 FR 4.5 W/2700K E14 ¹⁾	4.50 W	220...240 V	250	420	0.70	Warm White	2700 K	250 lm	≥80
ST CLAS B 25 FR 4.5 W/2700K E14 ¹⁾	4.50 W	220...240 V	250	420	0.70	Warm White	2700 K	250 lm	≥80
PAR16 25 120° 4.5 W/2700K GU10 FR ¹⁾	4.50 W	220...240 V	250	420	0.70	Warm White	2700 K	250 lm	≥80
ST CLAS P 40 FR 5.5 W/2700K E14 ¹⁾	5.50 W	220...240 V	210	340	0.70	Warm White	2700 K	470 lm	≥80
ECO CLAS B 5.5 W/2700K E14 FR ¹⁾	5.50 W	220...240 V	210	340	0.70	Warm White	2700 K	470 lm	≥80

Product description	Dimensions & weight	Temperatures & operating conditions	Lifespan		Additional product data		Capabilities
	Overall length	Ambient temperature range	Nominal lamp life time	Number of switching cycles	Base (standard designation)	Mercury-free	Dimmable
ST CLAS A 60 FR 9 W/2700K E27 ¹⁾	114.0 mm	-20...+40 °C	25000 h	100000	E27	Yes	No
ST CLAS P 25 FR 4.5 W/2700K E14 ¹⁾	85.0 mm	-20...+40 °C	25000 h	100000	E14	Yes	No
ST CLAS B 25 FR 4.5 W/2700K E14 ¹⁾	100.0 mm	-20...+40 °C	25000 h	100000	E14	Yes	No
PAR16 25 120° 4.5 W/2700K GU10 FR ¹⁾	56.0 mm	-20...+40 °C	25000 h	100000	GU10	Yes	No
ST CLAS P 40 FR 5.5 W/2700K E14 ¹⁾	91.0 mm	-20...+40 °C	25000 h	100000	E14	Yes	No
ECO CLAS B 5.5 W/2700K E14 FR ¹⁾	107.0 mm	-20...+40 °C	25000 h	100000	E14	Yes	No

Product description	Certificates & standards
	Energy efficiency class
ST CLAS A 60 FR 9 W/2700K E27 ¹⁾	A+
ST CLAS P 25 FR 4.5 W/2700K E14 ¹⁾	A
ST CLAS B 25 FR 4.5 W/2700K E14 ¹⁾	A
PAR16 25 120° 4.5 W/2700K GU10 FR ¹⁾	A

Certificates & standards

Product description	Energy efficiency class
ST CLAS P 40 FR 5.5 W/2700K E14 ¹⁾	A+
ECO CLAS B 5.5 W/2700K E14 FR ¹⁾	A+

¹⁾ All technical parameters apply to the entire lamp/Due to the complex production process for light-emitting diodes, the typical values shown for the technical LED parameters are purely statistical values that do not necessarily match the actual technical parameters of each individual product, which can vary from the typical value

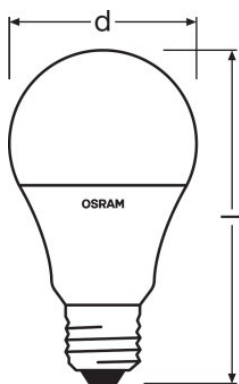

ST CLAS A 60 FR 9 W/2700K E27

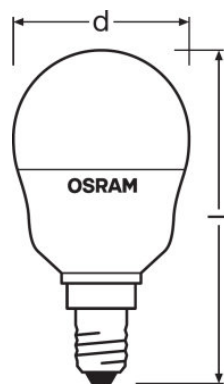

ST CLAS P 25 FR 4.5 W/2700K E14

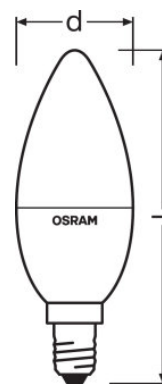

ST CLAS B 25 FR 4.5 W/2700K E14

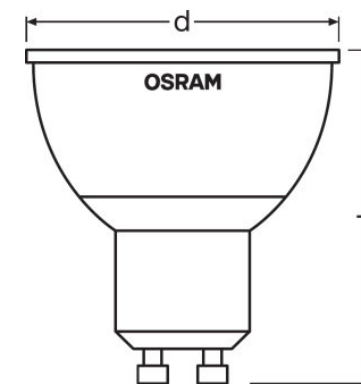

PAR16 25 120° 4.5 W/2700K GU10 FR

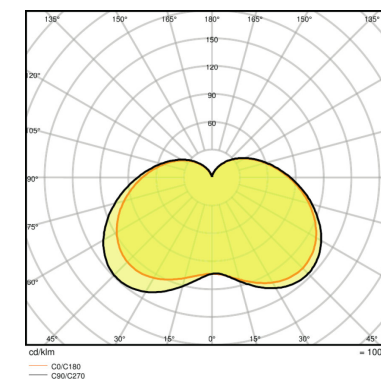
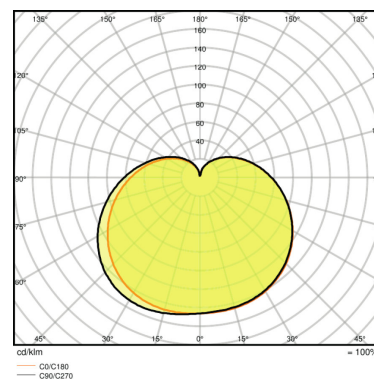
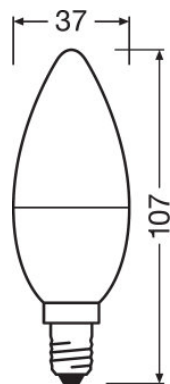
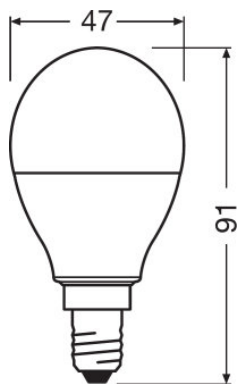

ST CLAS P 40 FR 5.5 W/2700K E14

ECO CLAS B 5.5 W/2700K E14 FR

ST CLAS P 40 FR 5.5 W/2700K E14

ECO CLAS B 5.5 W/2700K E14 FR

APPLICATION ADVICE

For more detailed application information and graphics please see product datasheet.

LOGISTICAL DATA

Product code	Packaging unit (Pieces/Unit)	Dimensions (length x width x height)	Gross weight	Volume
4058075045682	Shipping carton box 6	416 mm x 153 mm x 201 mm	777.00 g	12.79 dm ³
4058075091740	Shipping carton box 12	416 mm x 153 mm x 256 mm	1143.00 g	16.29 dm ³
4058075045729	Shipping carton box 6	285 mm x 153 mm x 201 mm	728.00 g	8.76 dm ³
4058075045743	Shipping carton box 6	262 mm x 153 mm x 201 mm	698.00 g	8.06 dm ³
4058075091764	Shipping carton box 12	262 mm x 153 mm x 256 mm	857.00 g	10.26 dm ³

Product code	Packaging unit (Pieces/Unit)	Dimensions (length x width x height)	Gross weight	Volume
4058075045767	Shipping carton box 6	322 mm x 154 mm x 201 mm	738.00 g	9.97 dm ³
4058075144392	Shipping carton box 6	285 mm x 153 mm x 201 mm	634.00 g	8.76 dm ³
4058075144316	Shipping carton box 6	262 mm x 153 mm x 201 mm	634.00 g	8.06 dm ³

The mentioned product code describes the smallest quantity unit which can be ordered. One shipping unit can contain one or more single products. When placing an order, for the quantity please enter single or multiples of a shipping unit.

DISCLAIMER

Subject to change without notice. Errors and omission excepted. Always make sure to use the most recent release.