

PRODUCT FAMILY DATASHEET HALOTRONIC HTi

Dimmable electronic transformers for low-voltage halogen lamps



AREAS OF APPLICATION

- Effect and accent lighting
- Living rooms
- Object lighting
- Conference rooms
- Restaurants
- Recessed and surface-mounted ceiling luminaires
- Shop lighting
- Event rooms

PRODUCT FAMILY BENEFITS

- Very low power consumption thanks to high efficiency
- Through-wiring possible on the primary side
- Large temperature range
- Protective operation throughout the entire partial-load range for long lamp life

PRODUCT FAMILY FEATURES

- DALI transformer for low voltage halogen lamps
- Electrical isolation between the primary side and the secondary side
- Short-circuit protection, overload protection, overtemperature protection: electronically reversible
- Energy efficiency: $\geq 91\%$ (according to ErP regulation 2012/1194/EC)
- Device fits also for special applications where dimming below 1 % is required

TECHNICAL DATA

Electrical data

Product description	Lamp wattage	Line current	Operating frequency	Nominal voltage	Nominal output voltage
HTI DALI 105/230...240 DIM	35...105 W	0.45 A	40 kHz ¹⁾	230...240 V	11.6 / 11.4 V ²⁾

¹⁾ Approximately

²⁾ 105 W

Dimensions & weight

Product description	Length	Width	Height	Wire preparation length, input side	Wire preparation length, output side	Mounting hole spacing, length
HTI DALI 105/230...240 DIM	170.0 mm	44.0 mm	34.0 mm	8.0 mm	8.0 mm	140.0 mm

Product description	Product weight
HTI DALI 105/230...240 DIM	160.00 g

Product line drawing

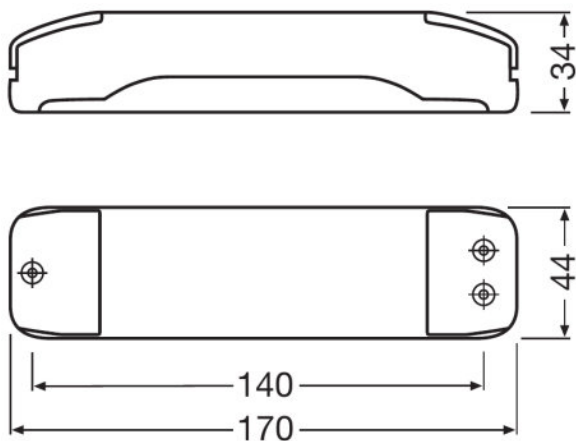

HTI DALI 105/230...240 DIM

Temperatures & operating conditions

Product description	Ambient temperature range
HTI DALI 105/230...240 DIM	-20...+50 °C

Additional product data

Product description	Design / version
HTI DALI 105/230...240 DIM	Long with cable clamp

Capabilities

Product description	Dimming method
HTI DALI 105/230...240 DIM	DALI or Touch DIM/Touch DIM Sensor

Certificates & standards

Product description	Approval marks – approval
HTI DALI 105/230...240 DIM	E1 approval / VDE / VDE-EMC

Product description	Standards	Type of protection
HTI DALI 105/230...240 DIM	Acc. to EN 55015:2006 + A1:2007/Acc. to EN 61000-3-2/Acc. to EN 61547/Acc. to EN 61347-2-2	IP20

APPLICATION ADVICE

For more detailed application information and graphics please see product datasheet.

SALES AND TECHNICAL SUPPORT











Sales and Technical Support www.ledvance.com

COUNTRY SPECIFIC INFORMATION

Product description	Product code	METEL code	SEG number	STK number	UK Org
HTI DALI 105/230...240 DIM	4008321420633	OSRHTIDALI105	7980331	4030093	-

DOWNLOAD DATA

File
 Product Datasheet 321473_ATI HTi DALI 105230-240 DIM (G+GB)

	Certificates 504178_EAC HT family
	Certificates VDE EMC Certificate 40024187
	Certificates VDE ENEC Certificate 40024665
	Declarations of conformity 710835_EC-DOC Halotronic
	Installation/Operation notice 334136_Technical guide - HALOTRONIC for low-voltage halogen lamps
	Installation guide 334563_HALOTRONIC INTELLIGENT – Manual
	CAD data 3-dim 317452_HTL 105230-240 and HTL 225230-240 9900052
	CAD data 3-dim 317453_HTL 105230-240 and HTL 225230-240 9900052
	CAD data 3-dim 317454_HTL 105230-240 and HTL 225230-240 9900052
	CAD data PDF 317451_HTL 105230-240 and HTL 225230-240 9900052

LOGISTICAL DATA

Product code	Packaging unit (Pieces/Unit)	Dimensions (length x width x height)	Gross weight	Volume
4008321420640	Shipping carton box 10	235 mm x 89 mm x 183 mm	1711.00 g	3.83 dm ³

The mentioned product code describes the smallest quantity unit which can be ordered. One shipping unit can contain one or more single products. When placing an order, for the quantity please enter single or multiples of a shipping unit.

DISCLAIMER

Subject to change without notice. Errors and omission excepted. Always make sure to use the most recent release.