

PRODUCT DATASHEET

PTi 70/220...240 I

POWERTRONIC INTELLIGENT PTi I | ECG for HID lamps, with cable clamp



AREAS OF APPLICATION

- Shop lighting
- Health and fitness areas (in luminaires with protection class IP66 or higher)
- Effect and accent lighting

PRODUCT FAMILY BENEFITS

- Extended terminal section enables mains looping
- Screw-down cable clamps for reliable strain relief
- Long reliable life at maximum permitted temperatures
- Automatic safety shutdown of lamps in the event of a defect or at end of life (EoL)

PRODUCT FAMILY FEATURES

- Energy Efficiency Index EEI: A2
- Supply voltage: 220...240 V
- Line frequency: 50...60 Hz
- RI suppression: to EN 55015/CISPR 15
- Safety: to EN 61347-2-12
- Line harmonics according to EN 61000-3-2
- Immunity according to EN 61547

TECHNICAL DATA

Electrical data

Lamp wattage	73 W
Line current	0.36 A ¹⁾
Ignition voltage	4.5 kVp
Operating frequency	0.200...0.240 kHz
System wattage [AGGR]	79.00 W
ECG efficiency	92 %
Input voltage AC	198...264 V
Nominal voltage	220...240 V
Mains frequency	50...60 Hz
Power factor λ	0.95 ²⁾
Inrush current	45 A ³⁾
Max. ECG no. on circuit breaker 10 A (B)	7 ⁴⁾
Max. ECG no. on circuit breaker 16 A (B)	13 ⁴⁾
Max. no. of ECGs on 16A MCB with EBN-OS	32 ⁴⁾
Maximum current for mains looping	16 A
Protective conductor current	0.3 mA
U-OUT (working voltage)	250 V
Max. working voltage between LH and LL	250 V
Max. working voltage betw. LL/LH & earth	250 V
Max. capacitance of wire ECG/lamp	120 pF

¹⁾ At 230 V_{AC}

²⁾ Minimum

³⁾ t_{width} = 250 μs (measured at 50 % I_{peak})

⁴⁾ Type B

Dimensions & weight

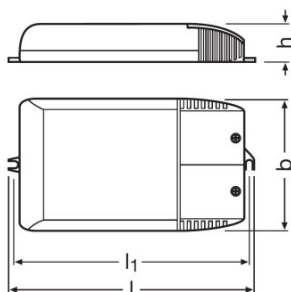

Length	171.0 mm
Width	83.0 mm

Height	32.0 mm
Mounting hole spacing, length	163.0 mm
Cable cross-section, input side	0.75...2.5 mm ²
Cable cross-section, output side	0.75...2.5 mm ²
Wire preparation length, input side	10...11 mm
Wire preparation length, output side	10...11 mm
Product weight	290.00 g

Colors & materials

Casing material	Plastic
------------------------	---------

Temperatures & operating conditions

Ambient temperature range	-25...+50 °C
Maximum temperature at tc test point	80 °C

Lifespan

ECG lifetime	50000 h ¹⁾
---------------------	-----------------------

¹⁾ At maximum T_c / 10% failure rate

Additional product data

Design / version	With cable clamp
-------------------------	------------------

Capabilities

Max. cable length to lamp/LED module	1.5 m
Overheating protection	Power reduction and switch off at T > 80 °C at the tc point
Overvoltage protection at 275...300 V	48 h ¹⁾
Overvoltage protection at 300...320 V	2 h ¹⁾
Overvoltage protection at 320...350 V	5 min ²⁾
ECG reset time	> 0.5 s
Cable/wire types, input side	NYM-J 3x1.5 / NYM-J 3x2.5 / H05VV-F 3x1.5 / NHXMH-J 3x1.5 mm ²
Cable/wire types, output side	SIHF-J 3x1.5 / SIHF-J 3x2.5 / SIHSI 3x1.0 mm ²
Dimmable	No
Restriction on ignition time	20 min
Suitable for fixtures with prot. class	I

¹⁾ Control gear switches off after 40 s

²⁾ Control gear switches off or does not start

Certificates & standards

Approval marks – approval	ENEC 10 / VDE / VDE-EMC / EAC / C-Tick
Type of protection	IP20
EEI – Energy Label	A2

Standards

Acc. to EN 61347-2-12/Acc. to EN 55015/Acc. to EN 61000-3-2/Acc. to EN 61547/Acc. to EN 62493

Wiring Diagram

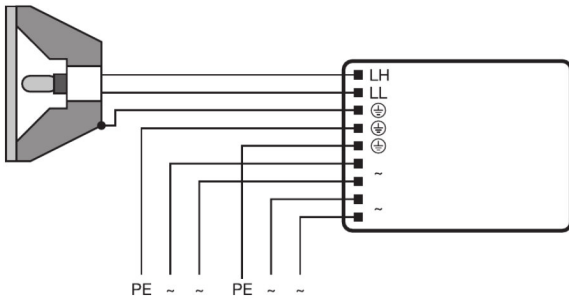

Wiring diagram





SAFETY ADVICE







Ballast losses and lamp heat radiation can lead to heat accumulation in a completely closed case. Therefore it is necessary to ensure that the temperature at the measuring point t of the ECG does not exceed the maximum value.

ATTENTION!

For safety reasons disconnect the device before replacing the lamp!

DOWNLOAD DATA

File	
	Addon Technical Information 323171_ATI PTi 70220-240 I
	Tender documents 339884_Tender Document for POWERTRONIC EVG.eng
	Certificates 554891_EAC PT family
	Certificates VDE ENEC Certificate 40035813
	Declarations of conformity VD EMC Certificate 40025469

	Declarations of conformity EU Declaration of Conformity 3363432
	Installation/Operation notice 334206_Technical guide - POWERTRONIC for HID-lamps (GB)
	Operating instructions 590731_EAC - PTI I PT-FIT I
	CAD data 3-dim 313448_155x83x32 9900003
	CAD data 3-dim 313472_155x83x32 9900003
	CAD data 3-dim 313492_155x83x32 9900003
	CAD data PDF 313385_155x83x32 9900003

LOGISTICAL DATA

Product code	Packaging unit (Pieces/Unit)	Dimensions (length x width x height)	Gross weight	Volume
4008321099518	Shipping carton box 20	436 mm x 110 mm x 374 mm	6207.00 g	17.94 dm ³

The mentioned product code describes the smallest quantity unit which can be ordered. One shipping unit can contain one or more single products. When placing an order, for the quantity please enter single or multiples of a shipping unit.

DISCLAIMER

Subject to change without notice. Errors and omission excepted. Always make sure to use the most recent release.

POWERTRONIC INTELLIGENT PTi I | ECG for HID lamps, with cable clamp