

PRODUCT DATASHEET

PTo 35/220...240

POWERTRONIC OUTDOOR PTo | ECG for HID lamps, for outdoor lighting



AREAS OF APPLICATION

- Suitable for luminaires of protection classes I and II
- Suitable for outdoor applications in luminaires with IP > 54

PRODUCT FAMILY BENEFITS

- Energy savings up to 30 % (compared to CCG operation) thanks to 3DIM (except PTo 35)
- High surge protection: up to 3 kV (L-N) / 4 kV (L/N-PE)
- Automatic safety shutdown of lamps in the event of a defect or at end of life (EoL)
- Excellent thermal behavior for very high limit temperatures t_c and t_a

PRODUCT FAMILY FEATURES

- 3DIM functionality (StepDIM/AstroDIM/DALI)
- Energy Efficiency Index EEI: A2
- Lightning protection: up to 10 kV
- Supply voltage: 220...240 V
- Line frequency: 50...60 Hz
- Line harmonics according to EN 61000-3-2
- Immunity according to EN 61547
- RI suppression: to EN 55015
- Safety: to EN 61347-2-12
- Luminous flux factor 1 compared with CCG operation
- Not suitable for DC operation

TECHNICAL DATA

Electrical data

Lamp wattage	39 W
Line current	0.20 A ¹⁾
Ignition voltage	4.5 kVp
Operating frequency	0.165 kHz
System wattage [AGGR]	43.00 W
ECG efficiency	90 % ²⁾
Input voltage AC	198...264 V
Nominal voltage	220...240 V
Mains frequency	50...60 Hz
Power factor λ	0.95 ³⁾
Inrush current	35 A ⁴⁾
Max. ECG no. on circuit breaker 10 A (B)	7 ⁵⁾
Max. ECG no. on circuit breaker 16 A (B)	13 ⁵⁾
Max. no. of ECGs on 16A MCB with EBN-OS	32 ⁵⁾
Protective conductor current	0.1 mA
U-OUT (working voltage)	250 V
Max. working voltage between LH and LL	250 V
Max. working voltage betw. LL/LH & earth	250 V
Max. capacitance of wire ECG/lamp	120 pF
Surge capability (L-N)	3 kV
Surge capability (L/N-Ground)	4 kV

¹⁾ At 230 V_{AC}

²⁾ Approximately

³⁾ Minimum

⁴⁾ $t_{width} = 350 \mu s$ (measured at 50 % I_{peak})

⁵⁾ Type B

Dimensions & weight

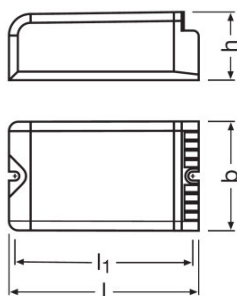

Length	133.0 mm
Width	77.0 mm
Height	48.0 mm
Mounting hole spacing, length	123.0 mm
Cable cross-section, input side	0.5...2.5 mm ²
Cable cross-section, output side	0.5...2.5 mm ²
Wire preparation length, input side	10...11 mm
Wire preparation length, output side	10...11 mm
Product weight	730.00 g

Colors & materials

Casing material	Plastic
------------------------	---------

Temperatures & operating conditions

Ambient temperature range	-25...+60 °C
Maximum temperature at tc test point	75 °C

Lifespan

ECG lifetime	60000 h ¹⁾
---------------------	-----------------------

¹⁾ At maximum T_c / 10% failure rate

Additional product data

Required IP rating of luminaire	≥ 54
Design / version	ECG outdoor
Encapsulated	Yes ¹⁾

¹⁾ PCB fully encapsulated + dust proof plastic housing

Capabilities

Max. cable length to lamp/LED module	1.5 m
Overheating protection	Power reduction and switch off at T > 75 °C at the tc point
ECG reset time	> 0.5 s
Dimmable	No
Restriction on ignition time	20 min
Suitable for fixtures with prot. class	I / II
Lightning stroke protection	With connected equipotentiality-terminal 10 surges with 10 kV acc. to IEC 61000-4-5

Certificates & standards

Approval marks – approval	ENEC 10 / VDE / VDE-EMC / EAC / C-Tick
Type of protection	IP20
EEL – Energy Label	A2

Standards

Acc. to EN 61347-2-12/Acc. to EN 55015/Acc. to EN 61000-3-2/Acc. to EN 61547

Wiring Diagram

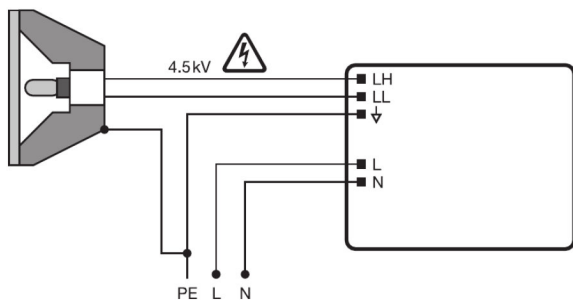

Wiring diagram

SAFETY ADVICE

Ballast losses and lamp heat radiation can lead to heat accumulation in a completely closed case. Therefore it is necessary to ensure that the temperature at the measuring point t of the ECG does not exceed the maximum value.



ATTENTION!









For safety reasons disconnect the device before replacing the lamp!

ADDITIONAL PRODUCT INFORMATION

- An external relay connected in front of the SD port is necessary in StepDIM installations. The relay needs to be selected in a way that it is not switched or hold by the occurring leakage currents in the installation.

DOWNLOAD DATA

File	
	Tender documents 339884_Tender Document for POWERTRONIC EVG.eng
	Certificates 554891_EAC PT family

	Certificates VDE ENEC Certificate 40035813
	Declarations of conformity VD EMC Certificate 40025469
	Declarations of conformity EU Declaration of Conformity 3363432
	Installation/Operation notice 334206_Technical guide - POWERTRONIC for HID-lamps (GB)
	Operating instructions 590728_EAC-PTO
	CAD data 3-dim 325148_PT035
	CAD data 3-dim 325149_PT035
	CAD data 3-dim 325150_PT035

LOGISTICAL DATA

Product code	Packaging unit (Pieces/Unit)	Dimensions (length x width x height)	Gross weight	Volume
4008321956323	Unpacked 1	- x - x -	730.00 g	
4008321956330	Shipping carton box 20	483 mm x 167 mm x 285 mm	15471.00 g	22.99 dm ³

The mentioned product code describes the smallest quantity unit which can be ordered. One shipping unit can contain one or more single products. When placing an order, for the quantity please enter single or multiples of a shipping unit.

DISCLAIMER

Subject to change without notice. Errors and omission excepted. Always make sure to use the most recent release.

POWERTRONIC OUTDOOR PTo | ECG for HID lamps, for outdoor lighting