

PRODUCT DATASHEET

QTi DALI 1X18 DIM

QUICKTRONIC INTELLIGENT DALI DIM T8 | ECG dimmable DALI for FL 26 mm



AREAS OF APPLICATION

- Suitable for use in emergency lighting systems as per EN 50172/DIN VDE 0108-100
- Installation in emergency lighting systems according to IEC 61347-2-3, appendix J
- Industry
- Open-plan offices, corridors and storage rooms
- Public buildings
- Sports halls and factories
- Strip lighting
- Suitable for luminaires of protection class I

PRODUCT FAMILY BENEFITS

- System+ Guarantee available
- Easy integration in luminaire thanks to same dimensions like DALI GI ECG
- TouchDIM function for easy and inexpensive dimming of several ECGs
- Same luminous flux with direct and alternating current
- Dimming of amalgam lamps without flickering or reduced lifespan
- Automatic restart after lamp replacement

PRODUCT FAMILY BENEFITS

- System+ Guarantee available
- Easy integration in luminaire thanks to same dimensions like DALI GI ECG
- TouchDIM function for easy and inexpensive dimming of several ECGs
- Same luminous flux with direct and alternating current
- Dimming of amalgam lamps without flickering or reduced lifespan
- Automatic restart after lamp replacement

DALI PRODUCT FEATURES

- Control via the DALI interface
- Compliance with the DALI Version-1 and IEC 60929
- Control input protected against overvoltage and polarity reversal (OSRAM ECG)

DALI PRODUCT FEATURES

- Control via the DALI interface
- Compliance with the DALI Version-1 and IEC 60929
- Control input protected against overvoltage and polarity reversal (OSRAM ECG)

TOUCH DIM AND TOUCH DIM SENSOR FUNCTION

- Manual dimming without controller and with standard switches
- Including memory function (double click) and soft start

TOUCH DIM AND TOUCH DIM SENSOR FUNCTION

- Manual dimming without controller and with standard switches
- Including memory function (double click) and soft start

PRODUCT FAMILY FEATURES

- Corridor function for direct connection of ECG to common motion sensor
- Corridor function with pre-programmed light program
- Touch DIM function for free parameterization of light value and turn on time
- Fit for SMART GRID for feedback of consumed mains power and lamp operating hours
- Fit for emergency function for automatic detection of emergency lighting by ECG
- Very low standby power consumption: < 0.2 W (A1 BAT)
- Lifetime: > 100,000 h (for T = 65 °C at T_c)
- Very high number of switching cycles: up to 300,000
- Dimming range: 1...100 % (3...100 % with compact fluorescent lamp)
- POWER2LAMP function for optimal matching of ECG power to lamp during lamp lifetime
- Line frequency: 0 Hz, 50...60 Hz, rectified AC

TECHNICAL DATA

Electrical data

| | |
|----------------------------|--------------|
| Input voltage AC | 198...264 V |
| Nominal voltage | 220...240 V |
| Mains frequency | 50...60 Hz |
| Input voltage DC | 154...276 V |
| Operating frequency | 51...120 kHz |

| | |
|---|------------------|
| Max. ECG no. on circuit breaker 10 A (B) | 17 ¹⁾ |
| Max. ECG no. on circuit breaker 16 A (B) | 28 ¹⁾ |
| Power loss in stand-by mode | 0.2 W |
| Inrush current | 24 A |

¹⁾ Type B

Light technical data

| | |
|----------------------|-------|
| Starting time | 0.6 s |
|----------------------|-------|

Dimensions & weight

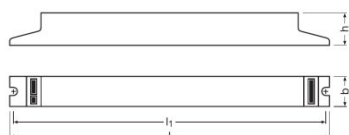

| | |
|---|---|
| Length | 360.0 mm |
| Width | 30.0 mm |
| Height | 21.0 mm |
| Mounting hole spacing, length | 350.0 mm |
| Product weight | 278.00 g |
| Wire preparation length, input side | 8.0...9.0 mm ¹⁾ |
| Wire preparation length, output side | 8.0...9.0 mm ¹⁾ |
| Cable cross-section, output side | 0.5...1.5 / 0.5...1.0 mm ² ²⁾ |
| Cable cross-section, input side | 0.5...1.5 / 0.5...1.0 mm ² ²⁾ |

¹⁾ Combi wiring

²⁾ Solid leads / Flexible

Temperatures & operating conditions

| | |
|---|------------------------|
| Ambient temperature range | -20...+50 °C |
| Permitted rel. humidity during operation | 5...85 % ¹⁾ |

¹⁾ Maximum 56 days/year at 85 %

Lifespan

| | |
|---------------------|------------------------|
| ECG lifetime | 100000 h ¹⁾ |
|---------------------|------------------------|

¹⁾ At $T_{case} = 65^{\circ}C$ at T_c point / 10% failure rate

Expected Lifetime

| Product name | Lamp group | | | | |
|-------------------|--------------|------------------------------|--------|--------|--------|
| QTi DALI 1X18 DIM | DULUX L 18 W | ECG ambient temperature [ta] | 40 | 50 | 60 |
| | | Temperature at tc-point [°C] | 45 | 55 | 65 |
| | | Lifetime [h] | 100000 | 100000 | 100000 |
| | L 18 W | ECG ambient temperature [ta] | 40 | 50 | 60 |
| | | Temperature at tc-point [°C] | 45 | 55 | 65 |
| | | Lifetime [h] | 100000 | 100000 | 100000 |

Capabilities

| | |
|---|---|
| Dimming interface | DALI / Touch DIM / Touch DIM Sensor |
| Dimming range | 1...100 % ¹⁾ |
| Dimmable | Yes |
| Overload protection | Yes |
| Overheating protection | Power reduction and switch off at T > 75 °C at the tc point |
| Suitable for fixtures with prot. class | I |
| End of lamp life safety shutdown | EOL T.2 |

¹⁾ Luminous flux

— Certificates & standards

| | |
|----------------------------------|---|
| Approval marks – approval | VDE / VDE-EMC / ENEC 10 / EL / GOST / RCM / CCC |
| Standards | Acc. to EN 61347-2-3/Acc. to EN 60929/Acc. to EN 55015:2006 + A1:2007/Acc. to EN 61000-3-2/Acc. to EN 61547/Acc. to IEC 62386-101:Ed1/Acc. to IEC 62386-102:Ed1 |
| EEL – Energy Label | A1 BAT |
| Protection class | I |
| Type of protection | IP20 |

Wiring Diagram

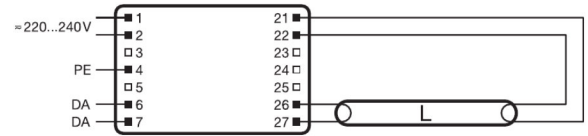
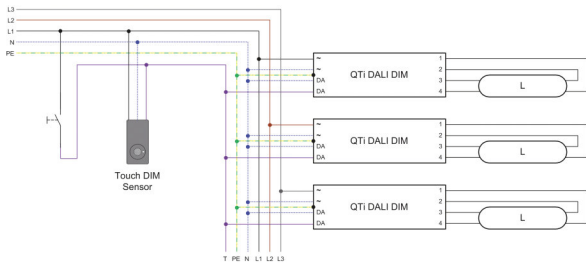

Wiring diagram

Wiring diagram

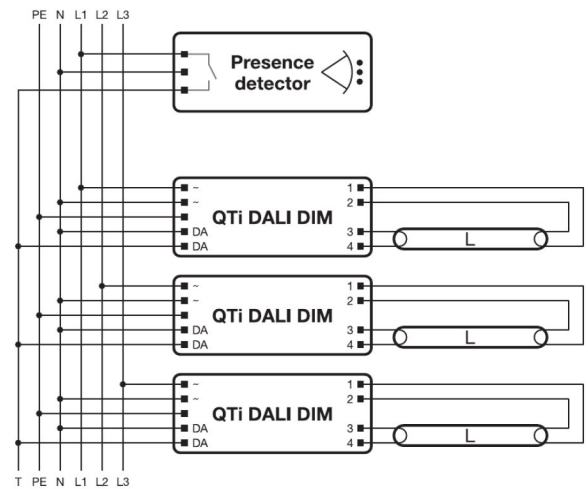
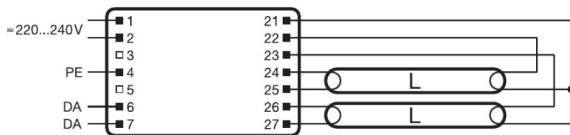





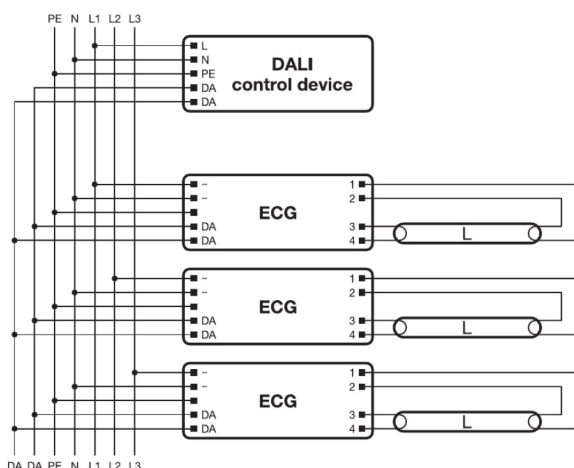







Wiring diagram







Wiring diagram



Wiring diagram

DOWNLOAD DATA

| File | |
|---|---|
|  | Addon Technical Information 502689_Frequent switching Quicktronic |
|  | Addon Technical Information 502785_ECG lifetime - QUICKTRONIC (DALI) DIM |
|  | Product Datasheet 321483_ATI QTi DALI 1x18 DIM (G+GB) |
|  | Brochures 333874_Bochure – DALI partner |
|  | Brochures 335514_Applications and luminares solutions |
|  | Certificates 554891_EAC PT family |
|  | Certificates 335097_INOTEC |
|  | Certificates 335125_ENECVDE-Marks approval |
|  | Certificates 335135_Manufacturer's declaration – Burning-in of fluorescent lamps |
|  | Certificates 335153_Manufacturer's declaration – Low stand-by |
|  | Certificates 335154_Manufacturer's declaration – EN 55015:2006+A1:2007 (300 MHz) |
|  | Certificates 335169_Manufacturer's declaration – LampECG combinations: Frequent switching |

| | |
|---|---|
|  | Certificates 335190_Manufacturer's declaration –Additional hints |
|  | Certificates 504208_VDE-EMC-CERTIFICATE QTI DALI DIM |
|  | Declarations of conformity 334957_Declaration of conformity |
|  | Installation/Operation notice 334142_Technical guide - ECGs for T5-lamps |
|  | Installation/Operation notice 493509_Technical application guide QUICKTRONIC Intelligent DALI DIM (GB) |
|  | Operating instructions 592411_EAC QT _i T5 DALI DIM |
|  | Operating instructions 592413_EAC QT _i T8 DALI DIM |
|  | CAD data 3-dim 313428_423x30x21 1881282 |
|  | CAD data 3-dim 313430_423x30x21 1881282 |
|  | CAD data 3-dim 313432_360x30x21 1881281 |
|  | CAD data 3-dim 313433_360x30x21 1881281 |
|  | CAD data 3-dim 313444_423x30x21 1881282 |
|  | CAD data 3-dim 313453_360x30x21 1881281 |
|  | CAD data PDF 313406_360x30x21 1881281 |
|  | CAD data PDF 313416_423x30x21 1881282 |

LOGISTICAL DATA

| Product code | Packaging unit (Pieces/Unit) | Dimensions (length x width x height) | Gross weight | Volume |
|---------------|------------------------------|--------------------------------------|--------------|----------------------|
| 4050300870403 | Unpacked 1 | - x - x - | 278.00 g | |
| 4050300870410 | Shipping carton box 20 | 392 mm x 98 mm x 165 mm | 6319.99 g | 6.34 dm ³ |

The mentioned product code describes the smallest quantity unit which can be ordered. One shipping unit can contain one or more single products. When placing an order, for the quantity please enter single or multiples of a shipping unit.

REFERENCES / LINKS

For more information on the system guarantee and the terms and conditions of the guarantee visit

- ▶ www.ledvance.com/system-guarantee

DISCLAIMER

Subject to change without notice. Errors and omission excepted. Always make sure to use the most recent release.

QUICKTRONIC INTELLIGENT DALI DIM T8 | ECG dimmable DALI for FL 26 mm

| Product name | Lamp group | Nominal current | Nominal wattage + Power loss | Luminous flux at 35 °C | Number of lighting outlets |
|-------------------|--------------|-----------------|------------------------------|------------------------|----------------------------|
| QTi DALI 1X18 DIM | DULUX F 18 W | 0.08 A | 18.00 W | 1100 lm | 1 |
| | DULUX L 18 W | 0.08 A | 18.00 W | 1200 lm | 1 |
| | L 18 W | 0.08 A | 18.30 W | 1350 lm | 1 |
| | L 18 W XT | 0.08 A | 18.30 W | 1350 lm | 1 |
| | L 18 W XXT | 0.08 A | 18.30 W | 1350 lm | 1 |