

# PRODUCT DATASHEET

## L 18 W/77

FLUORA T8 | Tubular fluorescent lamps 26 mm, with G13 bases, for plant growing



---

### AREAS OF APPLICATION

- Wherever there is not enough natural daylight for plants
- Public buildings
- Offices
- Shops
- Supermarkets and department stores
- Restaurants

---

### PRODUCT BENEFITS

- Promotes photobiological processes in plants
- Promotes plant growth



**TECHNICAL DATA**

Electrical data

Nominal voltage	57 V
Rated lamp efficacy (HF data 25 °C)	Under clarification by authority and standardization body
Rated wattage	18.00 W
Nominal wattage	18.00 W

Photometrical data

Rated lamp efficacy (standard condition)	31 lm/W
Rated luminous flux	550 lm
Luminous flux at 25 °C	550 lm
Light color	77
Nominal luminous flux	550 lm
Light color (designation)	FLUORA
Rated LLMF at 2,000 h	0.88
Rated LLMF at 4,000 h	0.83
Rated LLMF at 6,000 h	0.80
Rated LLMF at 8,000 h	0.77
Rated LLMF at 12,000 h	0.74
Rated LLMF at 16,000 h	0.72
Luminous flux	550 lm

Dimensions & weight

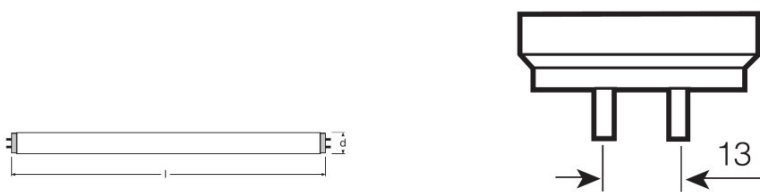

G13  
IEC 7004-51  
DIN 49653 T1

Tube diameter	26 mm
Length	590.0 mm
Length with base excl. base pins/connection	590.00 mm
Diameter	26.0 mm
Maximum diameter	26.0 mm

## Temperatures &amp; operating conditions

Rated ambient temp.w.max.luminous flux	25.0 °C
--	---------

## Lifespan

Service life	10000 h
Lifespan	20000 h <sup>1)</sup>
Rated lamp survival factor at 2,000 h	0.99
Rated lamp survival factor at 4,000 h	0.99
Rated lamp survival factor at 6,000 h	0.99
Rated lamp survival factor at 8,000 h	0.99
Rated lamp survival factor at 12,000 h	0.99
Rated lamp survival factor at 16,000 h	0.90
Rated lamp survival factor at 20,000 h	0.50
Operation mode LLMF/LSF	HF
Rated lamp life time	20000 h
Nominal lamp life time	20000 h

<sup>1)</sup> With preheat ECG

## Additional product data

Base (standard designation)	G13
Mercury content	4.5 mg
Show WEEE picto	Yes

## Capabilities

Suitable for indoor	Yes
---------------------	-----

## Certificates &amp; standards

Energy efficiency class	B
Energy consumption	23 kWh/1000h

## Light Distribution

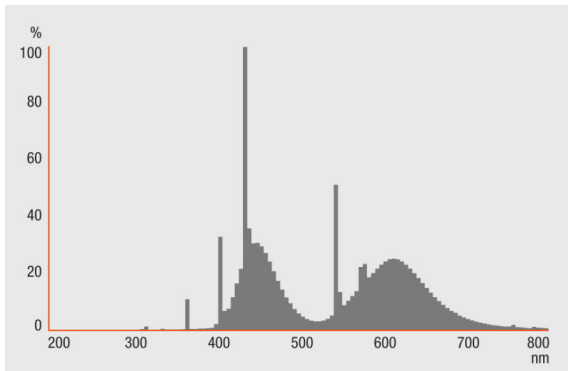

Spectral power distribution

## Wiring Diagram

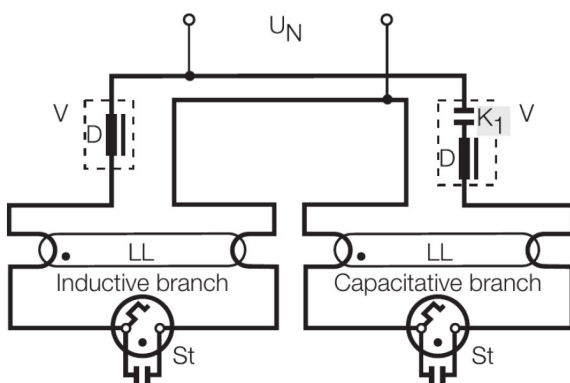

Wiring diagram

---

**SAFETY ADVICE**

In case of lamp breakage: [www.ledvance.com/brokenlamp](http://www.ledvance.com/brokenlamp)

---

**LOGISTICAL DATA**

Product code	Packaging unit (Pieces/Unit)	Dimensions (length x width x height)	Gross weight	Volume
4050300004235	Sleeves 1	609 mm x 28 mm x 30 mm	100.50 g	0.51 dm <sup>3</sup>
4008321205155	Shipping carton box 10	633 mm x 68 mm x 152 mm	1082.50 g	6.54 dm <sup>3</sup>
4050300325798	Sleeves 1	650 mm x 29 mm x 36 mm	120.50 g	0.68 dm <sup>3</sup>
4050300325804	Shipping carton box 10	677 mm x 73 mm x 177 mm	1386.40 g	8.75 dm <sup>3</sup>

The mentioned product code describes the smallest quantity unit which can be ordered. One shipping unit can contain one or more single products. When placing an order, for the quantity please enter single or multiples of a shipping unit.

---

**DISCLAIMER**

Subject to change without notice. Errors and omission excepted. Always make sure to use the most recent release.