

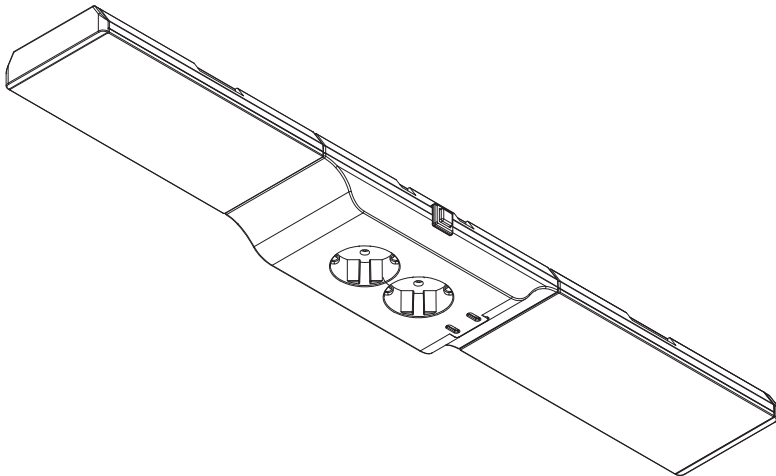

UNDERCABINET SOCKET FRAMELESS



	EAN	W	Im light source	Im output	K	θ_{beam} (°C)	V~	V_{DC}	mA	Hz	DF	∇ (°)	
UNDERCABINET SOCKET FL KIT830DUSBBK	4099854463211	10	600	500	3000	-20... +40	220- 240	-	88	50/ 60	>0.5	110	15000
UNDERCABINET SOCKET FL EXT 830 D BK	4099854463235	3.85	300	250	3000	-20... +40	-	36	-	-	>0.5	110	15000
UNDERCABINET SOCKET FL KIT830DUSBWT	4099854463273	10	600	500	3000	-20... +40	220- 240	-	88	50/ 60	>0.5	110	15000
UNDERCABINET SOCKET FL EXT 830 D WT	4099854463297	3.85	300	250	3000	-20... +40	-	36	-	-	>0.5	110	15000

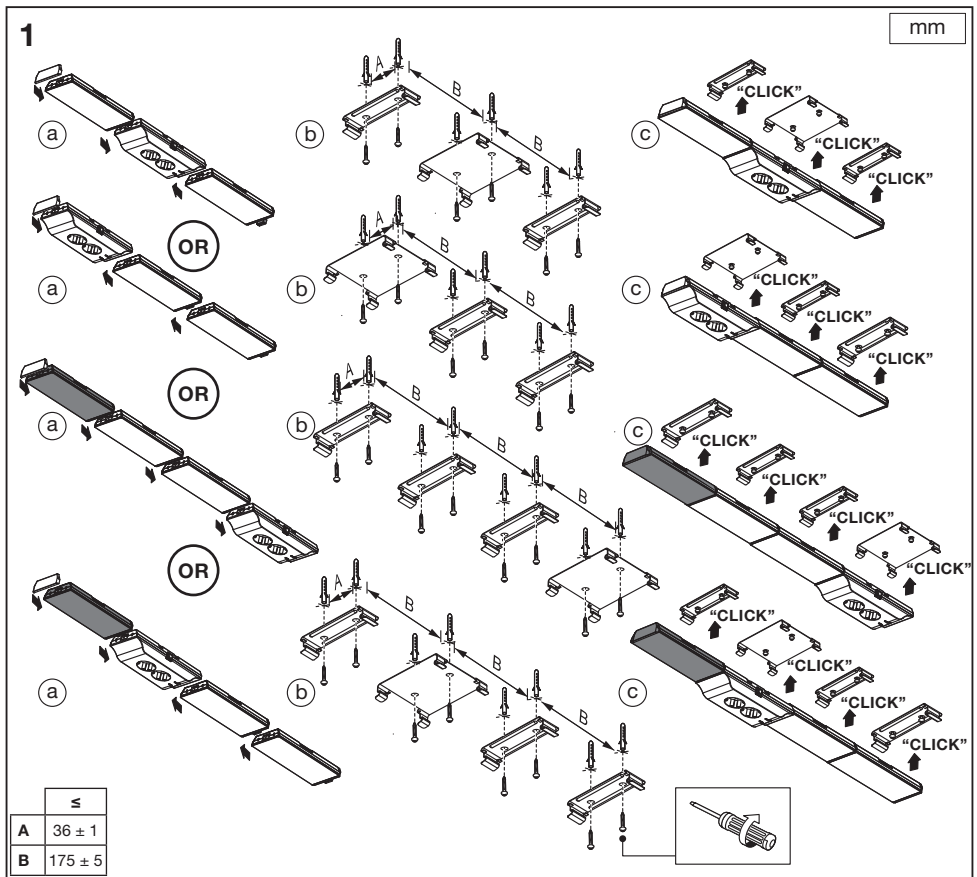
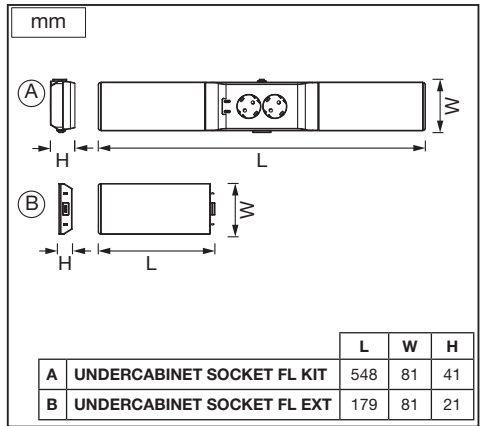
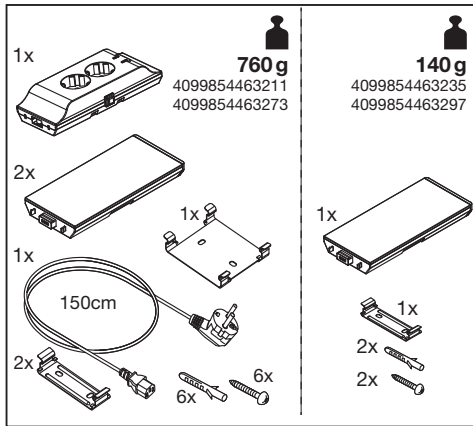

2

4099854463211
4099854463273

OR

OR

4099854463235
4099854463297

≤

UNDERCABINET SOCKET FL KIT830DUSBK	4
UNDERCABINET SOCKET FL KIT830DUSBWT	4

3

Total max. wattage:
2200W

4

III

III

ON|OFF >1s



10% 100% >3s



























5

2x USB-C,
5V 2.4A

2x EU socket
max.10A

6

					
	EAN	n		 QR code	ENERGY * X =
UNDERCABINET SOCKET FL KIT830DUSBBK	4099854463211	2	AC62780		G
UNDERCABINET SOCKET FL EXT 830 D BK	4099854463235	1	AC62780		G
UNDERCABINET SOCKET FL KIT830DUSBWT	4099854463273	2	AC62780		G
UNDERCABINET SOCKET FL EXT 830 D WT	4099854463297	1	AC62780		G

*  Dieses Produkt enthält eine Lichtquelle der Energieeffizienzklasse <X>.  This product contains a light source of energy efficiency class <X>.  Ce produit contient une source lumineuse de classe d'efficacité énergétique <X>.  Questo prodotto contiene una sorgente luminosa di classe di efficienza energetica <X>.  Este producto contiene una fuente luminosa de la clase de eficiencia energética <X>.  Este produto contém uma fonte de luz da classe de eficiência energética <X>.  Το προϊόν αυτό περιέχει φωτεινή πηγή της τάξης ενεργειακής απόδοσης <X>.  Dit product bevat een lichtbron van energie-efficiëntieklasse <X>.  Tämä tuote sisältää valonlähteen, jonka energiatehokkuusluokka on <X>.  Dette produktet inneholder en lyskilde med energieffektivitetsklasse <X>.  Dette produkt indeholder en lyskilde i energieffektivitetsklasse <X>.  Tento výrobek obsahuje světelný zdroj s třídou energetické účinnosti <X>.  Данный продукт содержит энергосберегающий источник света (класса <X>).  Ez a termék egy <X> energiatárolékonyosági osztályú fényforrást tartalmaz.  Ten produkt zawiera źródło światła o klasie efektywności energetycznej <X>.  Tento výrobok obsahuje svetelný zdroj triedy energetickej účinnosti <X>.  Ta izdelek vsebuje svetlobni vir razreda enerjske učinkovitost <X>.  Bu ürün, enerji verimliliği sınıfında bir ışık kaynağı içerir <X>.  Ovaj proizvod sadržava izvor svjetlosti klase energetske učinkovitosti <X>.  Acest produs conține o sursă de lumină cu clasă de eficiență energetică <X>.  Тоzi продукт включва светлинен източник с клас на енергийна ефективност <X>.  Toode sisaldab energiatõhususe klassi <X> valgusallikat.  Šiame gaminyje yra šviesos šaltinis, kurio energijos vartojimo efektyvumo klasė <X>.  Si s ražojums satur gaismas avotu, kura energoefektivitātes klase ir <X>.  Ovaj proizvod sadrži izvor svetlosti klase energetske efikasnosti <X>.  Цей виріб містить джерело світла класу енергоефективності <X>.  Бул өнімде <X> энергия тиімділігі класының жарық көзі бар.



4099854463211, 4099854463273:



4099854463235, 4099854463297:



LEDVANCE SASU
CQM, 5 rue d'Altorf
67120 Molsheim France
www.ledvance.com

© LEDVANCE Ltd, Sterling House,
810 Mandarin Court, Warrington,
Cheshire, WA1 1GG, United Kingdom

G11215111
18.03.2025